

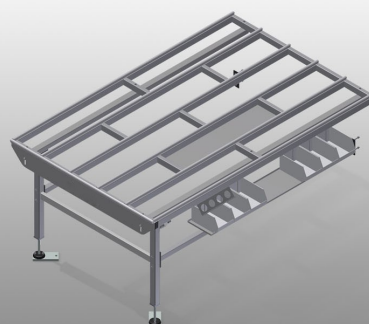

HT 2000 E

Assembly tables



Modular work table for a production line (basic module). Stable steel construction. Universal system of work tables for lines with a continuous production flow. Modular system: basic module + additional module. Add-on elements for individualised expansion. Additional modules are easy to install. Versatile work table for all applications: for example, as an individual table in the production flow, as an in-line workstation for assembly work, as a work table for gasket insertion, for the post-processing of special-order production items or as a buffer zone. Table supporting surface with plastic slide bars. Adjustable height. Simple installation with a modular system design.

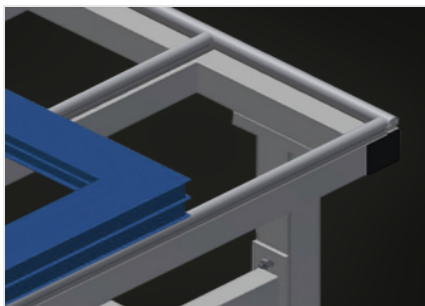

Supporting surfaces

Supporting surfaces with plastic slide bars

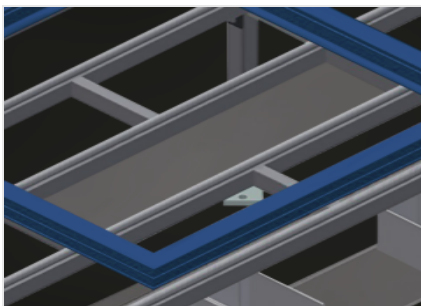

Storage tray

Storage tray for setting down tools and accessories

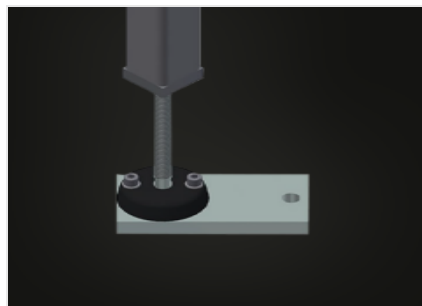

Height adjustment

Adjustable height; working height can be set to 850 - 1,000 mm by means of adjustable feet

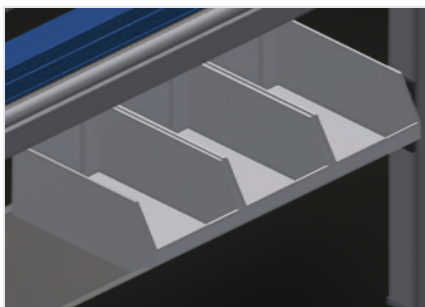

Storage area (Optional)

Storage area with 6 plastic trays for small accessories, hardware and screws



Brush strip (Optional)

Supporting surfaces with brush strip

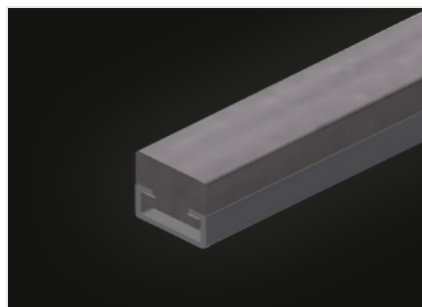

Felt strip (Optional)

Supporting surfaces with felt strip



Voilàp S.p.A.
Via Archimede, 10
41019 - Limidi di Soliera (MO)
ITALY

Tel 059 895411
Fax: 059 859404
P.IVA e C.F. 02057270361
info@somecopvc.com
www.somecopvc.com

The right to make technical alterations is reserved.

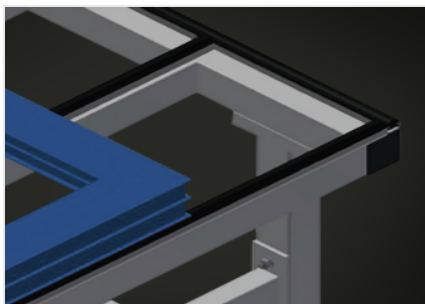

Rubber strips (Optional)

Supporting surfaces with rubber-knob profile



Tool rack (Optional)

Tool rack for pneumatic or electrical tools

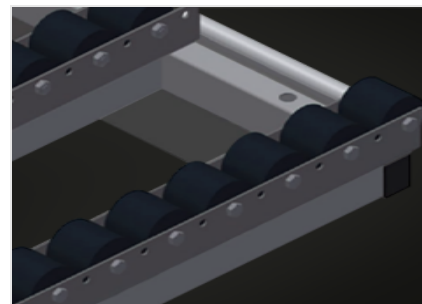

Roller support compl. (Optional)

Hard plastic rollers with polyamide coating, on plain bearings, load per roller 60 kg, convenient for transport and handling of PVC elements



End rack (Optional)

End rack for HT



End strip with knob profile (Optional)

End strip with knob profile for HT

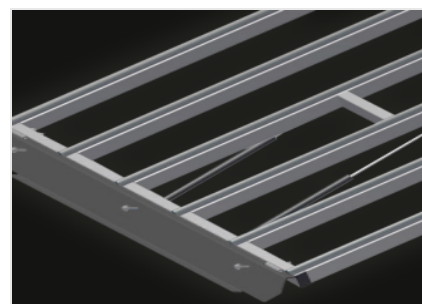

Fold-up pass-through section for HT (Optional)

Roller support, compl., for fold-up passthrough section



HT 2000 E / ASSEMBLY TABLES

DIMENSION AND WEIGHT

Length (mm)	2.000
Width (mm)	1.300
Height (mm)	850 ÷ 1.000
Weight (kg)	80

SUPPORTING SURFACE

Adjustable height	<input checked="" type="radio"/>
Table supporting surface with plastic slide bars	<input checked="" type="radio"/>
Table brush strip supporting surface	<input type="radio"/>
Table felt profile strip supporting surface	<input type="radio"/>
Table rubber knob profile	<input type="radio"/>
Roller support	<input type="radio"/>
Tool holder	<input type="radio"/>
Roller support for fold-up walk-through section	<input type="radio"/>
Fold-up walk-through section	<input type="radio"/>

CHARACTERISTICS

End strip with knob profile	<input type="radio"/>
End rack	<input type="radio"/>
Storage tray	<input type="radio"/>
4-fold compressed air supply	<input type="radio"/>

Included ● Available ○