

VR 3003 F

Vertical Rollers Conveyors

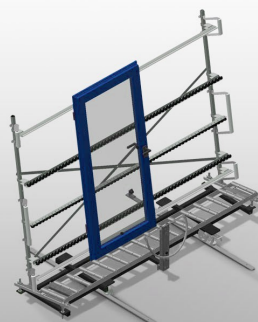

Vertical roller conveyor for transportation of window elements. Stable steel construction. Vertical roller conveyor for smooth transportation to the next work task as well as for transportation to storage and sorting of the finished windows. Easy handling of window elements. Every roller conveyor unit is 3.000 mm long. Plastic slide bars top and bottom. Three mini-roller conveyors with rubber rollers, diameter 50 mm. Basic unit with end rack. Vertical roller conveyor on rails with flanged rollers, mobile.



Support rollers

Rollers throughout, roller conveyor divided into three parts (L = 3 x 120 mm)



Mini-roller conveyor

Three mini-roller conveyors with rubber rollers, diameter 50 mm

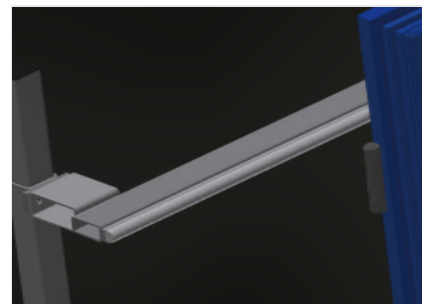

Back support

Rear back support with plastic slide bars, top and bottom



Grip

Grip makes pushing the roller conveyor on the rails easy



Mobility unit

Mobility unit with flanged rollers and fixing brake

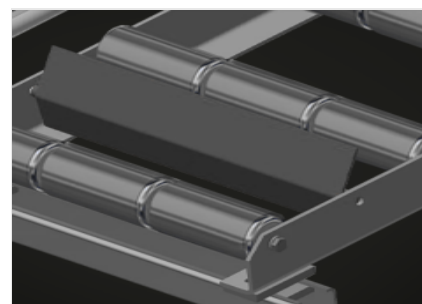

End stop (Optional)

End stop L = 3x120 mm



**Lead-in rollers
(Optional)**

Protective rollers for beginning or end of roller conveyor: - L = 500 mm (pair)
- L = 250 mm (pair)



**Profile protectors
(Optional)**

Profile protectors for support rollers 3x120 mm (Alum./33 x and Alum./48 x). Support rollers covered with protective tubing

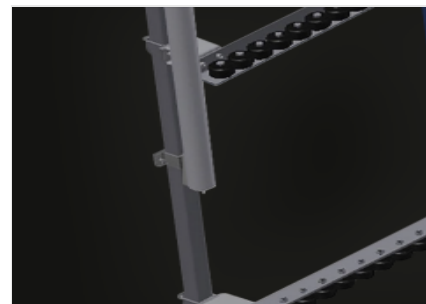

**Additional mini-roller conveyors
(Optional)**

Additional mini-roller conveyors with rubber rollers top/bottom



Rails (Optional)

Rails, 2.0 m, left and right



VR 3003 F / VERTICAL ROLLERS CONVEYORS

DIMENSION AND WEIGHT

Length (mm)	3.000
Width (mm)	1.000
Height (mm)	2.490
Support roller divided into three parts (mm)	3 x 120
Support height (mm)	2.100
Weight (kg)	180

CHARACTERISTICS

Load capacity (kg)	200
Mini-roller conveyors with rubber rollers, diameter 50 mm	3
Basic unit with end rack	●
Vertical roller conveyor on rails with flanged rollers mobile	●
Lead-in rollers L= 500 mm (pair)	○
Lead-in rollers L= 250 mm (pair)	○
Additional mini-roller conveyors with rubber rollers top/bottom	○
Profile protectors for L= 3x120 mm	○
End stop L= 3x120 mm	○
Rail 2,0 m left and right	○

Included ● Available ○