

VR 4003

Vertical Rollers Conveyors

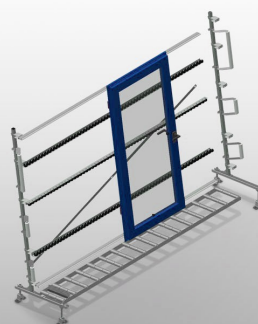

Vertical roller conveyor for transportation and storage of window elements. Stable steel construction. Expandable using modular system design. Vertical roller conveyor for smooth transportation and storage of window elements. Easy handling of window elements. Every roller conveyor unit is 4.000 mm long. Roller conveyor divided into three parts. Plastic slide bars top and bottom. Three mini-roller conveyors with rubber rollers, diameter 50 mm. Basic unit without end rack.



Support rollers

Rollers throughout, roller conveyor divided into three parts (L = 3 x 120 mm)



Mini-roller conveyor

Three mini-roller conveyors with rubber rollers, diameter 50 mm

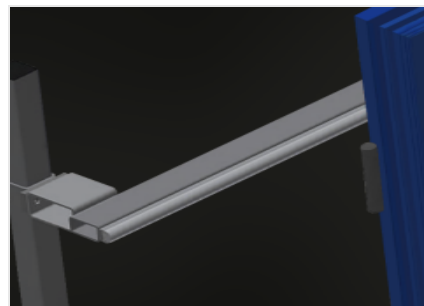

Back support

Rear back support with plastic slide bars, top and bottom



Roller conveyor height adjustment

Lower roller conveyor height can be adjusted by means of adjustable feet

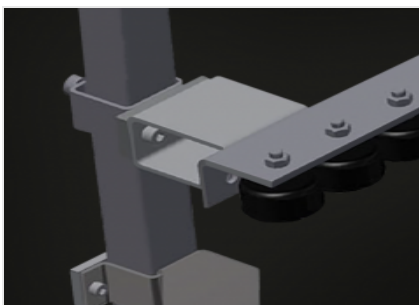

Mini-roller conveyor height adjustment

Mini-roller conveyor height is adjustable



End rack (Optional)

End rack is mandatory at end of line for VR 2000, VR 3000 and VR 4000

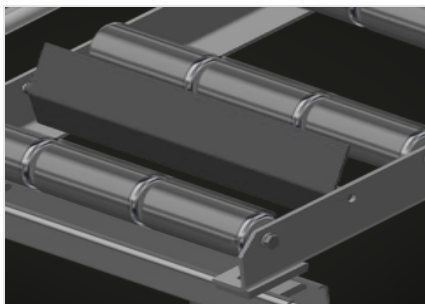

End stop (Optional)

End stop L = 3x120 mm



Lead-in rollers (Optional)

Protective rollers for beginning or end of roller conveyor: - L = 500 mm (pair)
- L = 250 mm (pair)

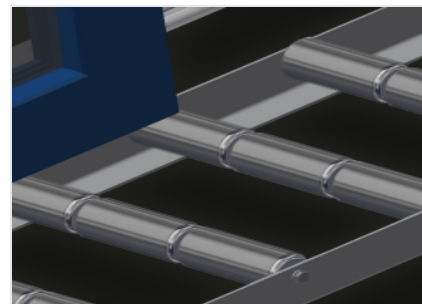

Profile protectors (Optional)

Profile protectors for support rollers 3x120 mm (Alum./33 x and Alum./48 x). Support rollers covered with protective tubing



Additional mini-roller conveyors (Optional)

Additional mini-roller conveyors with rubber rollers top/bottom



VR 4003 / VERTICAL ROLLERS CONVEYORS

DIMENSION AND WEIGHT

Length (mm)	4.000
Width (mm)	900
Height (mm)	2.400
Support roller divided into three parts (mm)	3 x 120
Support height (mm)	2.100
Weight (kg)	220

CHARACTERISTICS

Load capacity (kg)	200
Mini-roller conveyors with rubber rollers, diameter 50 mm	3
Basic unit with end rack	●
End rack	○
Lead-in rollers L= 500 mm (pair)	○
Lead-in rollers L= 250 mm (pair)	○
Additional mini-roller conveyors with rubber rollers top/bottom	○
Profile protectors for L= 3x120 mm	○
End stop L= 3x120 mm	○

Included ● Available ○